

The Twist & Sprout Culinary herb kit uses an all in one system in order to sow and grow herbs indoors, eliminating the need for separate pots and additional material for packaging.
The design utilises the properties of carton board in order to create two separate spaces which are joined by a twist. This separation keeps seed away from soil then acts as a water drainage system.
The pots themselves are a unique form which will stand out in both retail and domestic environments.
All materials included in the packaging can be easily recycled.

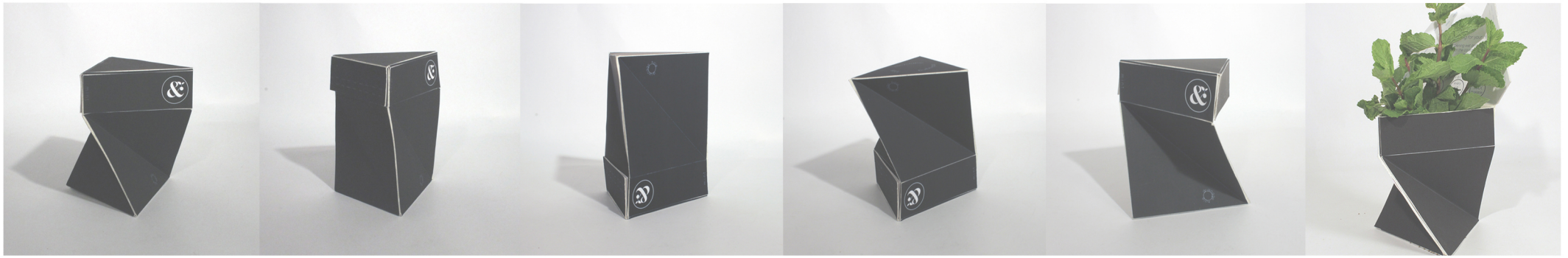

TWIST & SPROUT
culinary herb kit

Galvin Housley/Edinburgh Napier/4th Year Minor Project 1

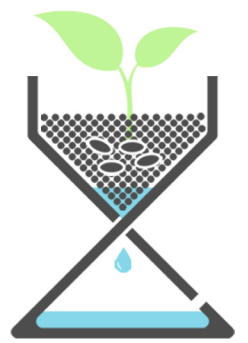
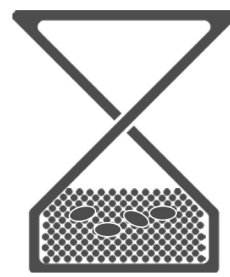
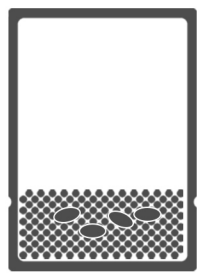
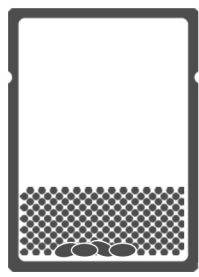
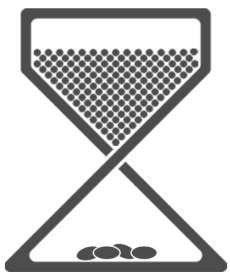

Twist open the pack

Shake to mix the contents

Flip the pack

Twist the pack closed

Twist the pack closed

Tear off the seal for the lid and pierce the 'drainage hole'

The instructions for the pack are on the main sleeve. The process allows the user to follow them to sow the seeds then follow the individual care instructions when the pack is open. This is to prevent the user from opening the pack before they have completed the twisting instructions.

A guide to caring for each herb is inside

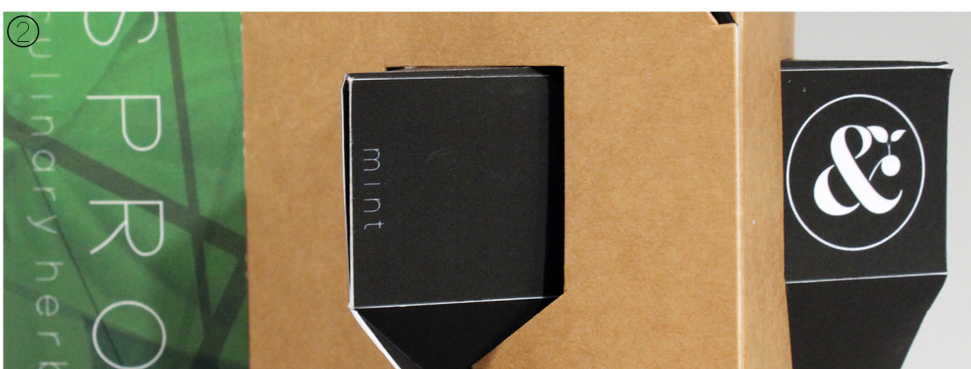
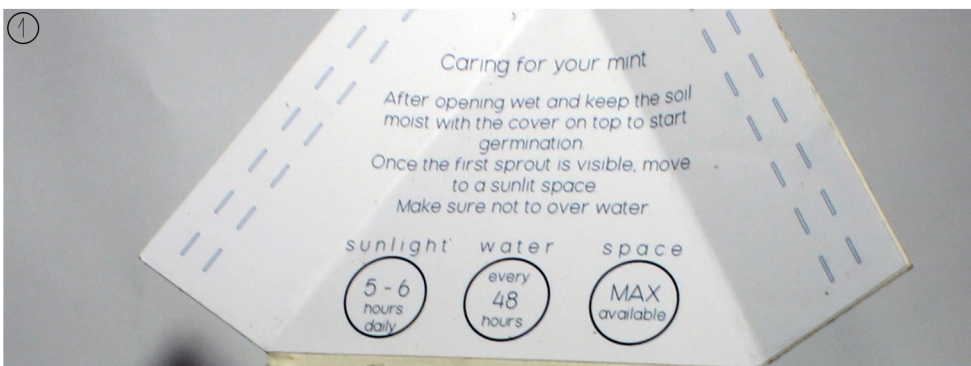

1. Details of individual herb care. Each pot contains its own set of instructions tailored to each herb as well as a set of generic best practices for sowing seeds.

2. Branding and herb types at point of sale.

3. Color combinations showing how the pots and herb leaves match the colours of the main box while leaving some of the original material finish visible.

At the end of the herb life, the user can either dispose of the soil outside, flatten the pack and recycle all aspects of the kit or take the new seeds, clean out the pot and re-sow the herb. All aspects of the packaging are 100% recyclable.

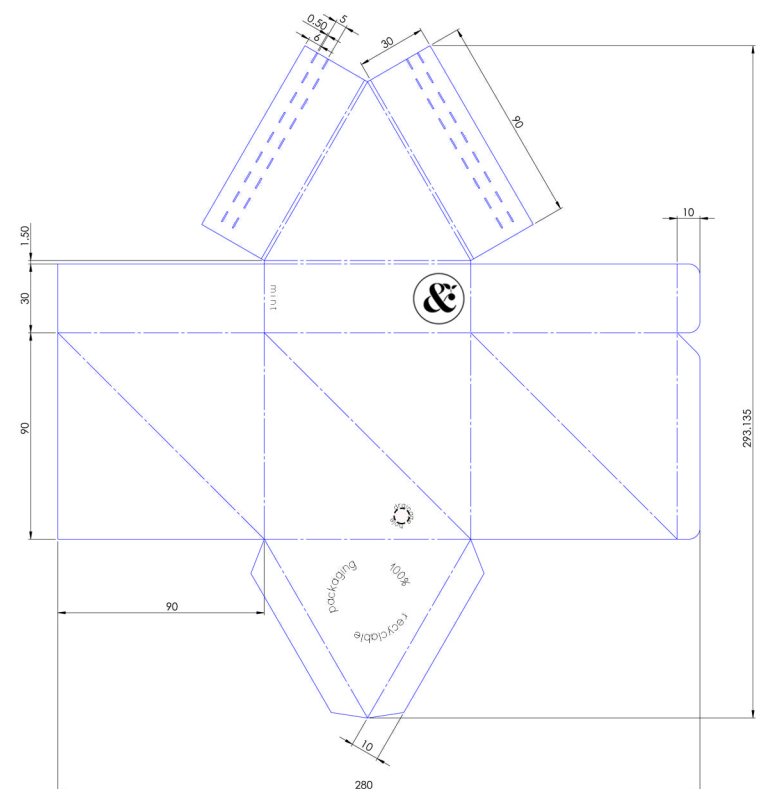
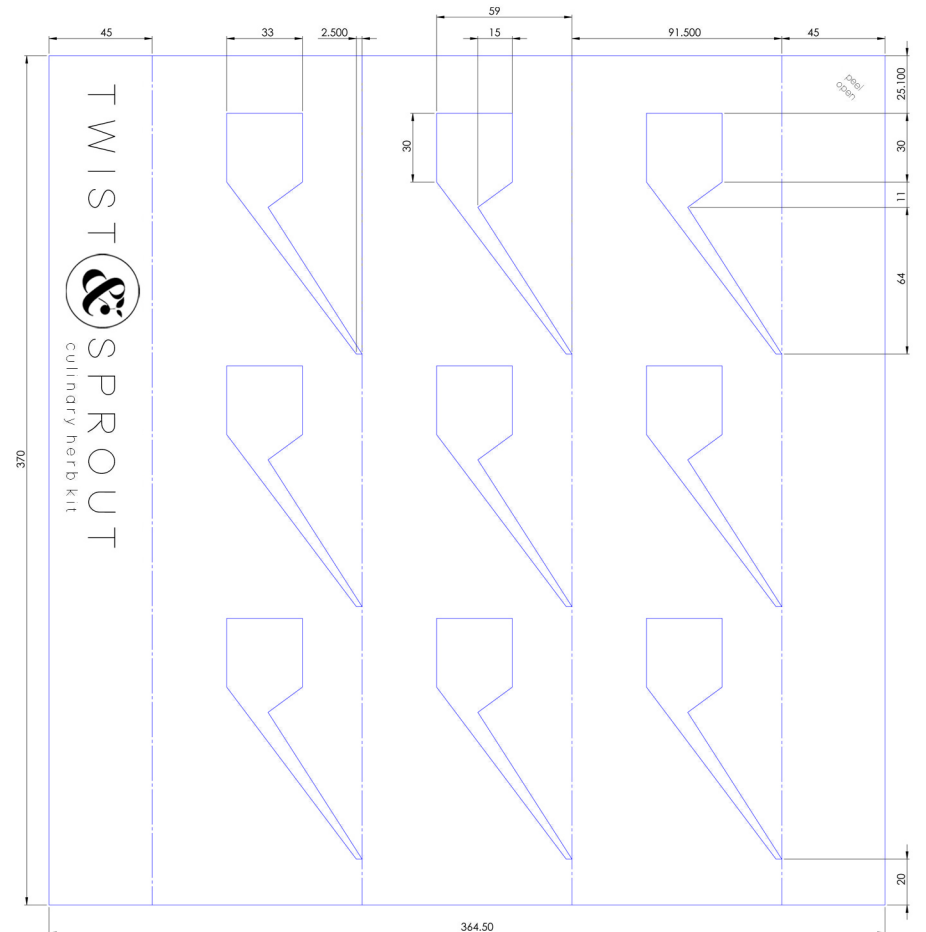

TWIST & SPROUT
culinary herb kit

Galvin Housley/Einburgh Napier/4th Year Minor Project 1

Development Considerations

Herb choice is essential:

- Growth season
- Sunlight requirements
- Growing space
- Water requirements

Each herb has unique properties:

- Aroma
- Direction of growth (up or out)
- Root depth
- Time for germination
- How to trim leaves
- What food they are usually mixed with
- Ease of growth

Herbs have certain elements in common:

- Similar soil types
- Number of seeds best required for successful growth
- Adequate drainage
- Germination process

The kit should be aimed towards a first time grower, linking into the newly fashionable aspect of the process which is described in the brief. It will be a starter kit in order to promote engagement.

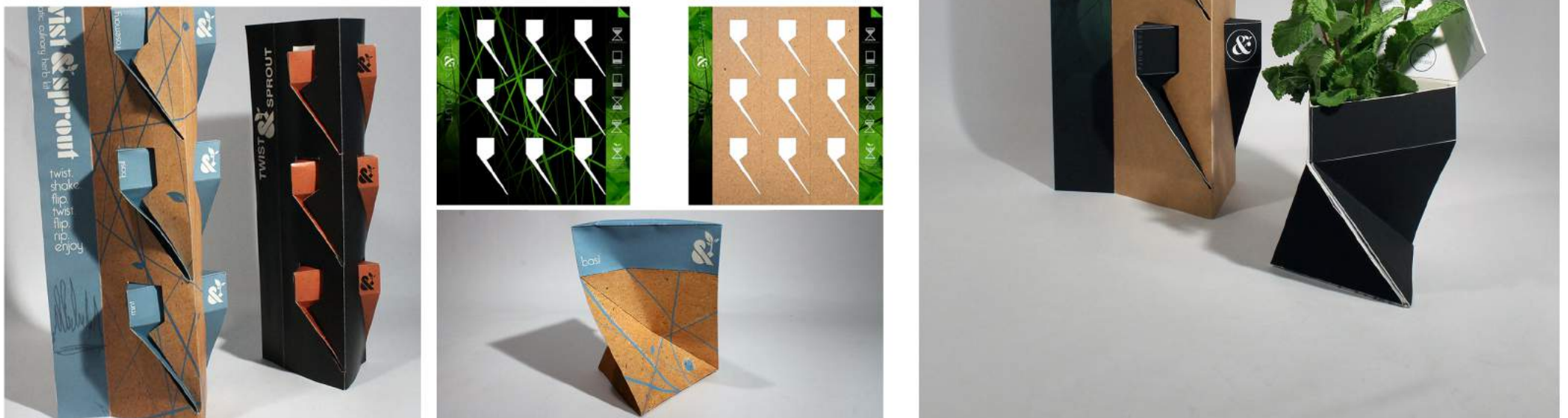
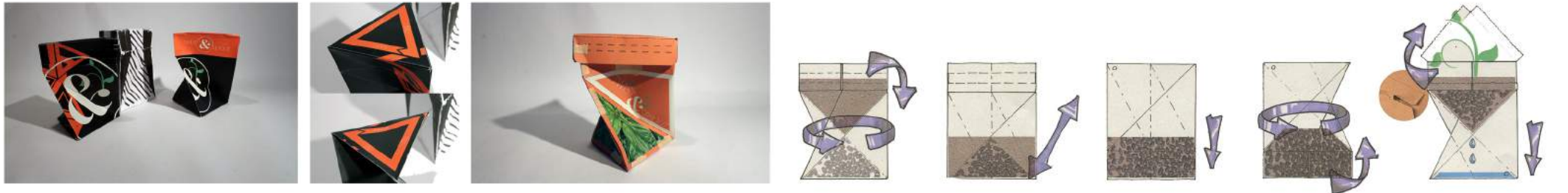
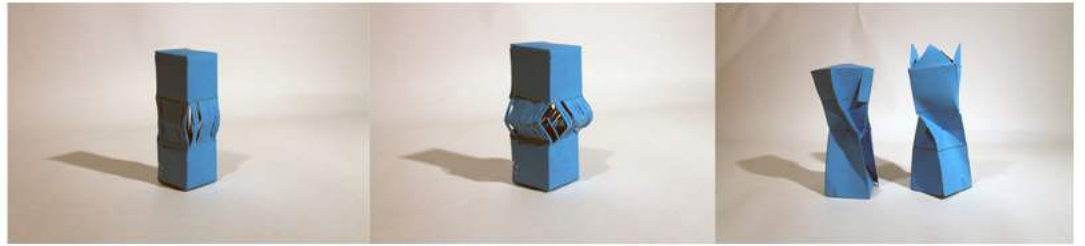

TWIST & SPROUT
culinary herb kit

Galvin Housley/Edinburgh Napier/4th Year Minor Project 1